

Surface Mount Bandpass Filter

50Ω 800 to 1000 MHz

SYBP-92+



CASE STYLE: TT1423

Features

- High power handling, 7W
- Small size
- Temperature stable
- Excellent rejection

Applications

- Military radio
- Cellular
- GSM
- ISM

Electrical Specifications at 25°C

Parameter	F#	Frequency (MHz)	Min.	Typ.	Max.	Unit	
Pass Band	Center Frequency	—	—	900	—	MHz	
	Insertion Loss	F1-F2	800 - 1000	—	1.9	2.8	dB
	VSWR	F1-F2	800 - 1000	—	1.6	2.1	:1
Stop Band, Lower	Insertion Loss	DC-F3	DC - 530	20	23	—	dB
	VSWR	DC-F3	DC - 530	—	12	—	:1
Stop Band, Upper	Insertion Loss	F4-F5	1550 - 3000	20	27	—	dB
	VSWR	F4-F5	1550 - 3000	—	10	—	:1

Maximum Ratings

Operating Temperature	-40°C to 85°C
Storage Temperature	-55°C to 100°C
RF Power Input	7W* max. at 25°C

*Passband rating, derate linearly to 3W at 85°C ambient
Permanent damage may occur if any of these limits are exceeded.

Functional Schematic

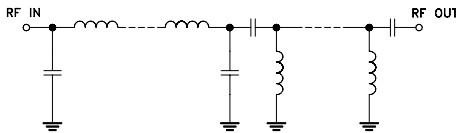

Typical Frequency Response

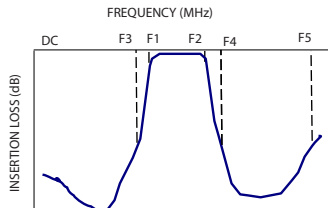

+RoHS Compliant

The +Suffix identifies RoHS Compliance. See our web site for RoHS Compliance methodologies and qualifications

Typical Performance Data at 25°C

Frequency (MHz)	Insertion Loss (dB)	VSWR (:1)
1.00	95.93	3014.56
100.00	57.95	179.36
200.00	57.87	46.52
300.00	57.43	24.06
400.00	44.24	16.44
450.00	37.39	14.52
500.00	30.07	13.16
530.00	25.54	12.43
700.00	4.73	3.24
800.00	2.24	1.64
1000.00	2.02	1.52
1550.00	28.43	7.73
1800.00	38.24	20.47
2000.00	36.48	27.60
2500.00	52.46	33.50
3000.00	33.80	29.13

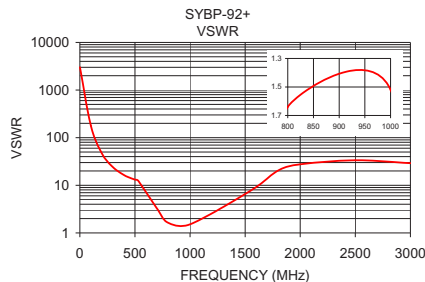
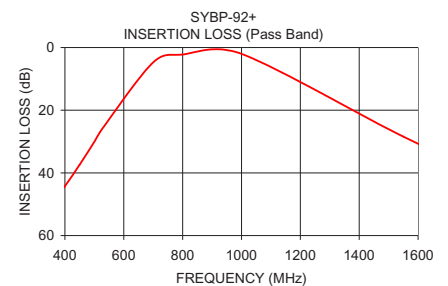
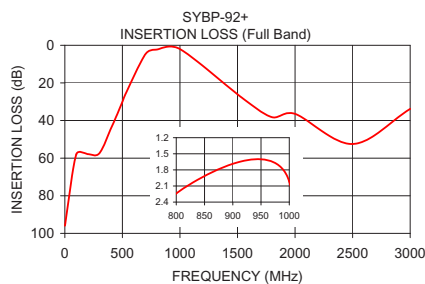

Notes

- Performance and quality attributes and conditions not expressly stated in this specification document are intended to be excluded and do not form a part of this specification document.
- Electrical specifications and performance data contained in this specification document are based on Mini-Circuit's applicable established test performance criteria and measurement instructions.
- The parts covered by this specification document are subject to Mini-Circuits standard limited warranty and terms and conditions (collectively, "Standard Terms"); Purchasers of this part are entitled to the rights and benefits contained therein. For a full statement of the Standard Terms and the exclusive rights and remedies thereunder, please visit Mini-Circuits' website at www.minicircuits.com/MCLStore/terms.jsp





Pin Connections

RF IN	4
RF OUT	6
GROUND	1,2,3,5

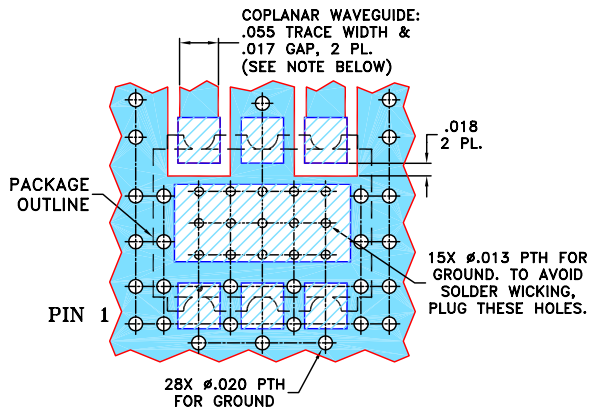
Demo Board MCL P/N: TB-517+
Suggested PCB Layout (PL-308)



NOTES:

1. COPLANAR WAVEGUIDE PARAMETERS ARE SHOWN FOR ROGERS R04350B WITH THICKNESS $.030 \pm .002$; COPPER: 1/2 OZ. EACH SIDE. FOR OTHER MATERIALS TRACE WIDTH AND GAP MAY NEED TO BE MODIFIED.
 2. BOTTOM SIDE OF THE PCB IS CONTINUOUS GROUND PLANE.
-  DENOTES PCB COPPER LAYOUT WITH SMOBC (SOLDER MASK OVER BARE COPPER)
-  DENOTES COPPER LAND PATTERN FREE OF SOLDER MASK

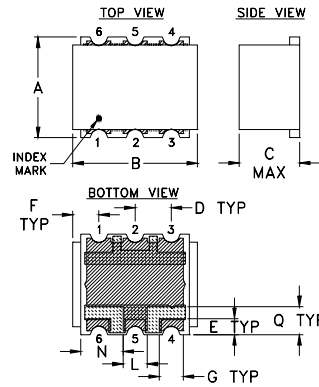

Outline Drawing

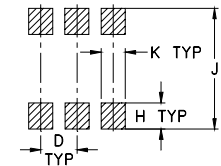

PCB Land Pattern



Suggested Layout,
Tolerance to be within $\pm .002$

-  METALLIZATION
-  SOLDER RESIST

Outline Dimensions (inch)

A	B	C	D	E	F	G	H
.25	.31	.15	.090	.040	.065	.060	.065
6.35	7.87	3.81	2.29	1.02	1.65	1.52	1.65
J	K	L	N	Q	wt.		
.300	.060	.060	.105	.070	grams		
7.62	1.52	1.52	2.67	1.78	0.50		

Notes

- A. Performance and quality attributes and conditions not expressly stated in this specification document are intended to be excluded and do not form a part of this specification document.
- B. Electrical specifications and performance data contained in this specification document are based on Mini-Circuit's applicable established test performance criteria and measurement instructions.
- C. The parts covered by this specification document are subject to Mini-Circuits standard limited warranty and terms and conditions (collectively, "Standard Terms"); Purchasers of this part are entitled to the rights and benefits contained therein. For a full statement of the Standard Terms and the exclusive rights and remedies thereunder, please visit Mini-Circuits' website at www.minicircuits.com/MCLStore/terms.jsp