

# RF SPDT Switch

## USB-1SP2T-A44

50Ω 0.1 to 43.5 GHz

### The Big Deal

- Ultra wide bandwidth 0.1 to 43.5 GHz
- High Isolation, 50 dB @ 40 GHz
- USB control and automation
- Daisy-chain control of up to 25 switches



Software Package

Case Style: UE3202

### Applications

- Millimeter wave signal switching
- 5G semiconductor / component test
- High throughput production test
- X / Ku / K / Ka band switching

#### Included Accessories

Model No.	Description	Qty.
USB-CBL-AC-3+	3.3 ft. USB C cable	1

#### RoHS Compliant

See our web site for RoHS Compliance methodologies and qualifications

### Product Overview

Mini-Circuits' USB-1SP2T-A44 is a fast switching solid-state SPDT covering an ultra-wide bandwidth, from 0.1 to 43.5 GHz. The solid-state design features an impressive combination of high isolation, low insertion loss and good linearity across the entire band. The switch is supplied in a low profile package with precision 2.92 mm RF connectors.

Full software support is provided, including our user-friendly GUI application for Windows and a full API with programming instructions for Windows and Linux environments (both 32-bit and 64-bit systems). Download the software from our website at <https://www.minicircuits.com/softwaredownload/solidstate.html>.

The daisy-chain control interface with “dynamic addressing” simplifies control integration, allowing multiple switches to be combined into a Master / Slave chain. Simply connect, then power on and the whole chain of up to 25 compatible switches can be controlled independently through a single USB and software interface.

### Key Features

Feature	Advantages
Fast switching sequences	Program automated switching sequences to run with extremely fast transitions (10ns) and no external control.
High performance	Solid-state design combining high isolation with low insertion loss from 0.1 to 43.5 GHz
Dynamic daisy-chain control	Control up to 25 switches through a single USB interface.
USB interface	USB HID interface provides easy compatibility with a wide range of software setups and programming environments

**Trademarks:** Windows is a registered trademark of Microsoft Corporation in the United States and other countries. Linux is a registered trademark of Linus Torvalds. Mac is a registered trademark of Apple Corporation. Pentium is a registered trademark of Intel Corporation. Neither Mini-Circuits nor the Mini-Circuits USB-1SP2T-A44 RF switch are affiliated with or endorsed by the owners of the above referenced trademarks.

Mini-Circuits and the Mini-Circuits logo are registered trademarks of Scientific Components Corporation.



## Electrical Specifications @ 0 to 50°C

Parameter	Port	Conditions	Min.	Typ.	Max.	Units
Operating Frequency			0.1		43.5	GHz
Insertion Loss	COM to any active port	0.1 to 18 GHz	-	1.5	3.0	dB
		18 to 26 GHz	-	2.7	4.0	
		26 to 35 GHz	-	3.3	4.5	
		35 to 40 GHz	-	4.0	5.5	
		40 to 43.5 GHz	-	5.5	-	
Isolation	Between ports 1 and 2	0.1 to 18 GHz	53	65	-	dB
		18 to 26 GHz	45	60	-	
		26 to 35 GHz	45	56	-	
		35 to 40 GHz	43	52	-	
		40 to 43.5 GHz	41	47	-	
	COM to any terminated port (Active states)	0.1 to 18 GHz	53	65	-	
		18 to 26 GHz	45	55	-	
		26 to 35 GHz	45	52	-	
		35 to 40 GHz	42	50	-	
		40 to 43.5 GHz	39	46	-	
	COM to any terminated port (Disconnected state – ports 1 & 2 terminated)	0.1 to 18 GHz	50	65	-	
		18 to 26 GHz	43	52	-	
		26 to 35 GHz	43	51	-	
35 to 43.5 GHz		40	48	-		
VSWR	COM port (active) <sup>1</sup>	0.1 to 18 GHz	-	1.20	-	:1
		18 to 26 GHz	-	1.50	-	
		26 to 35 GHz	-	1.65	-	
		35 to 40 GHz	-	1.80	-	
		40 to 43.5 GHz	-	2.00	-	
	Any port connected to COM	0.1 to 18 GHz	-	1.20	-	
		18 to 26 GHz	-	1.50	-	
		26 to 35 GHz	-	1.65	-	
		35 to 40 GHz	-	1.80	-	
		40 to 43.5 GHz	-	2.20	-	
	Any terminated port	0.1 to 18 GHz	-	1.20	-	
		18 to 26 GHz	-	1.30	-	
		26 to 35 GHz	-	1.45	-	
35 to 43.5 GHz		-	1.90	-		
Power Input @ 1 dB Compression	COM to any active port	0.1 to 43.5 GHz	-	+27	-	dBm
IP3 <sup>2</sup>	COM to any active port	0.1 to 43.5 GHz	-	50	-	dBm
Transition Time <sup>3</sup>	-	-	-	10	-	ns
Minimum dwell time <sup>4</sup>	High Speed Mode	-	-	15	-	µs
Switching Time (USB) <sup>5</sup>	-	-	-	2	-	ms
Supply voltage (Vcc)	USB port	-	4.75	5	5.25	V <sub>DC</sub>
Supply Current (Icc) <sup>6</sup>		-	-	100	150	mA
Current Pass-through <sup>7</sup>		-	-	-	500	
Operating RF Input Power	Any active port to COM port (Hot & Cold Switching)	0.1 to 40 GHz	-	-	+24	dBm
		40 to 43.5 GHz	-	-	+23	
	Any terminated port	0.1 to 40 GHz	-	-	+24	
		40 to 43.5 GHz	-	-	+23	
	COM to any port	0.1 to 40 GHz	-	-	+24	
		40 to 43.5 GHz	-	-	+23	

<sup>1</sup> COM port is reflective in disconnected state.

<sup>2</sup> IP3 is tested with 1 MHz span between signals, +12 dBm per tone.

<sup>3</sup> Transition time spec represents the time that the RF signal paths are interrupted during switching and thus is specified without communication delays.

<sup>4</sup> Minimum dwell time is the shortest time that can be achieved between 2 switch transitions when programming an automated switch sequence.

<sup>5</sup> Switching time(USB) is the time from issuing a single software command via USB to the switch state changing. The most significant factor is the host PC, influenced by CPU load and USB protocol. The time shown is an estimate for a medium CPU load and USB 2.0 connection.

<sup>6</sup> Current consumption specified for a single unit without any slave modules.

<sup>7</sup> Pass through current is the maximum current handling of a unit with slave modules attached. If controlling a large number of slave modules additional power supplies should be included to ensure this limit is not exceeded. See page 4 for details.

## Absolute Maximum Ratings

Operating Temperature	0°C to 50°C	
Storage Temperature	-20°C to 60°C	
V <sub>USB</sub> Max.	6V	
RF power in for each port	0.1 to 40 GHz	+25 dBm
	40 to 43.5 GHz	+24 dBm
Total RF power in for all ports	0.1 to 40 GHz	+28 dBm
	40 to 43.5 GHz	+26 dBm
DC voltage at RF port	0 V	

Permanent damage may occur if any of these limits are exceeded. Operating in the range between operating power limits and absolute maximum ratings for extended periods of time may result in reduced life and reliability.

## Connections

RF ports (COM, 1, 2)	(2.92 mm female)
USB	(USB type C female)
Serial Control Out	(10 Pin Digital Snap Fit female) <sup>8</sup>
Serial Control In	(10 Pin Digital Snap Fit female) <sup>8</sup>

<sup>8</sup> Mating connector is Hirose ST40X-10S-CV(30)

## Block Diagram

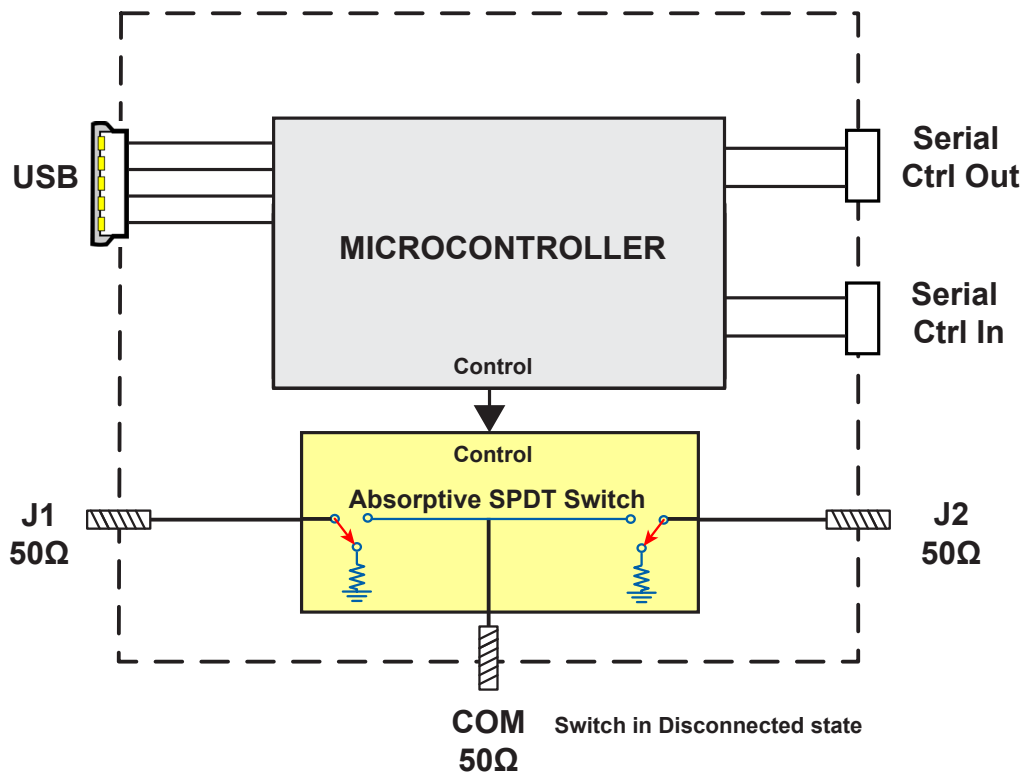

1. Simultaneous, bidirectional RF signal transmission with symmetrical performance

## Connecting multiple modules (Daisy Chain)

The USB-1SP2T-A44 is designed to connect up to 25 modules in series (Daisy chain) using dynamic addressing, meaning there is no need to specifically set the address of the modules, the addresses will be set automatically as part of establishing the communications with the PC. The module connected to the PC USB port will be assigned address 0 (Master), the first module connected to it will get address 1 (slave) and subsequent modules incrementing up to address 24 (slave).

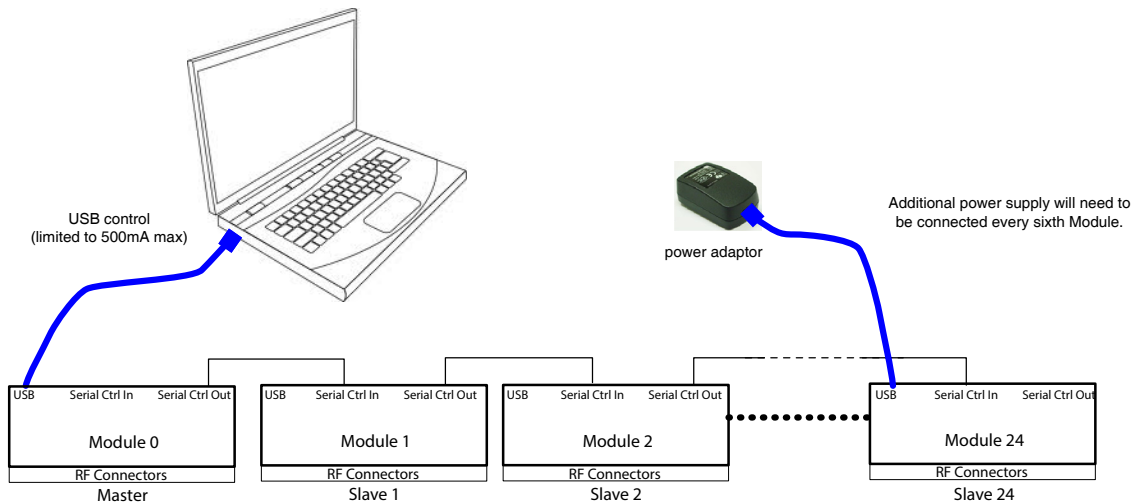

Connections between modules will be made using the serial in/out ports with the module connected to the PC as a master and all other as slave modules. All control will be through the master module (address zero) which is the only one communicating with the PC. Serial control out port of each module should be connected to the serial control in port of the next module. Power can be supplied from the PC via the master module or from additional power supplies connected to the USB ports of slave units.

Connecting an additional power supply will automatically cut off power draw from the serial control in port for the module connected.

The Serial master/slave bus allows connecting modules of different types to the same daisy chain as long as all support Mini-Circuits dynamic addressing setup. To add a new module to the set up simply connect the module to the setup and refresh the address listing, no need to reset any of the existing modules or assign addresses manually.

Note: Different module types may have different current consumption which will change the number of units which can be connected before additional power supply is needed.

## Outline Drawing (UE3202)

### Connections

RF ports (COM, 1, 2)	(2.92mm female)
USB	(USB type C female)
Serial Control Out	(10 Pin Digital Snap Fit female) <sup>9</sup>
Serial Control In	(10 Pin Digital Snap Fit female) <sup>9</sup>

<sup>9</sup> Mating connector is Hirose ST40X-10S-CV(30)

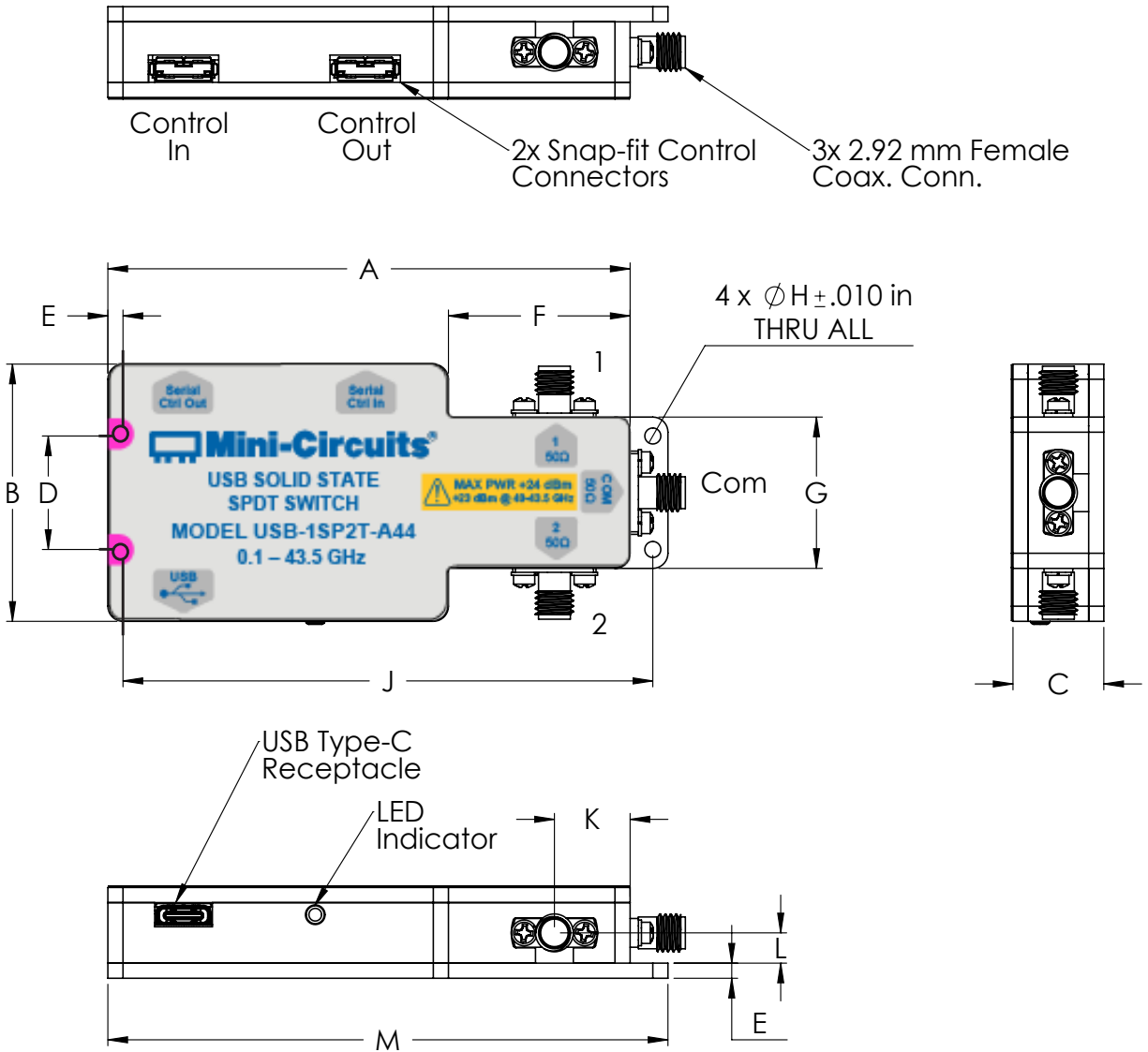

### Outline Dimensions ( $\frac{\text{inch}}{\text{mm}}$ )

A	B	C	D	E	F	G	H	J	K	L	M	WT. GRAMS
3.45	1.70	0.60	0.75	0.10	1.20	1.00	0.106	3.50	0.50	0.20	3.70	550
87.63	43.18	15.24	19.05	2.54	30.48	25.40	2.69	88.90	12.70	5.08	93.98	

## Typical Performance Curves

**Insertion Loss (COM-J1) over Temperature**

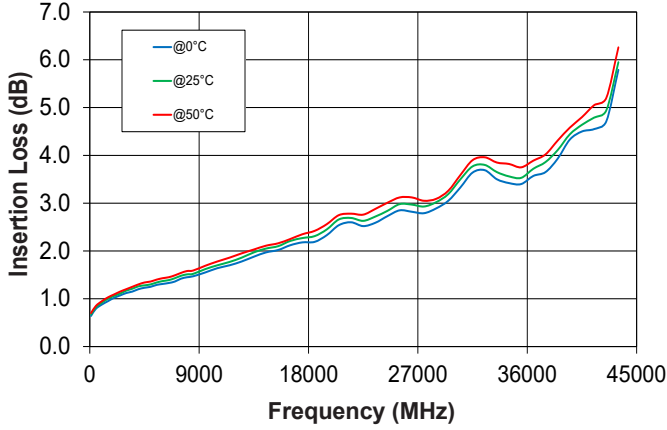

**Insertion Loss COM-J1/J2**

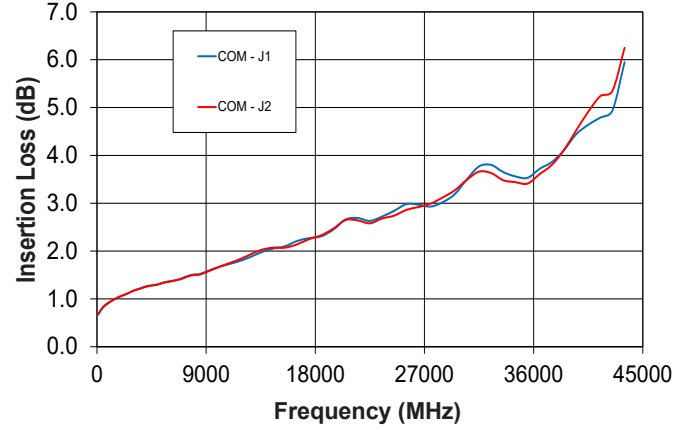

**Isolation Com to J2 (J1 Active)**

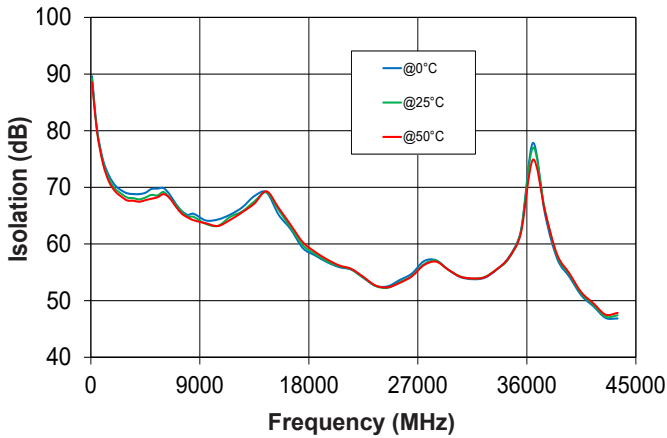

**Isolation Com to J1 (J2 Active)**

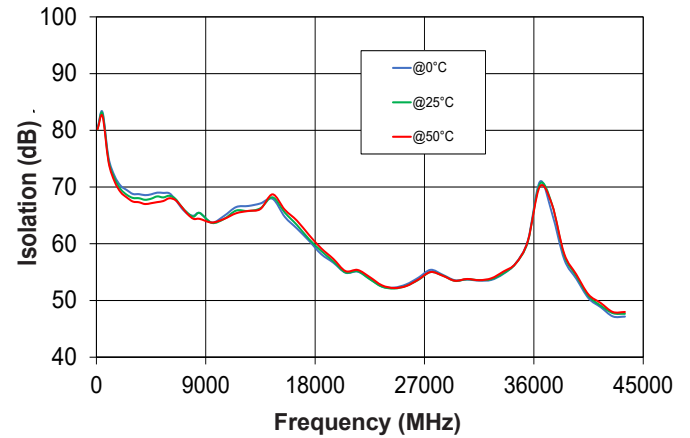

**Isolation J1 to J2 (J2 active)**

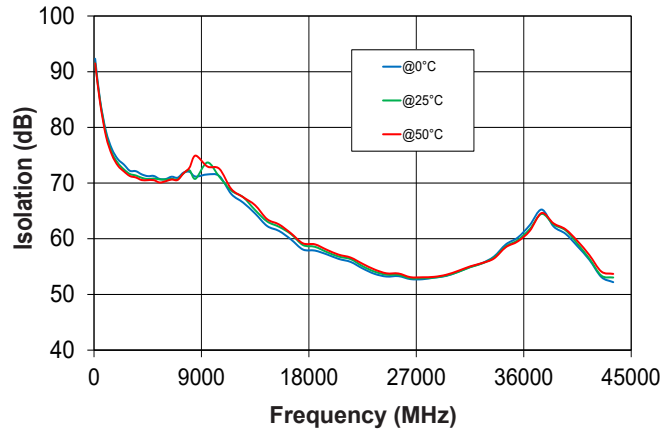

## Typical Performance Curves (Continued)

**VSWR J1 @ Disconnected state over Temperature**

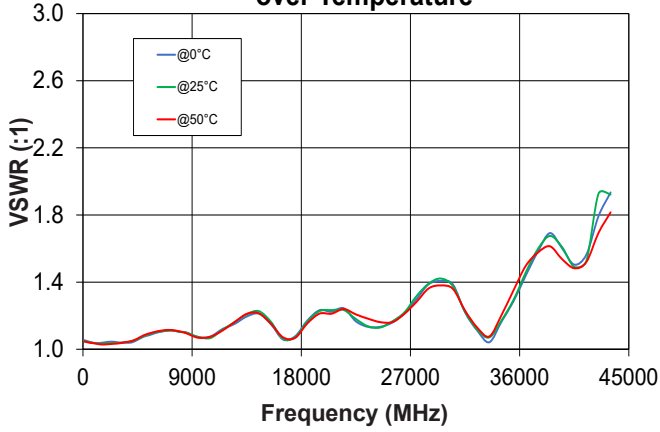

**VSWR J2 @ Disconnected state over Temperature**

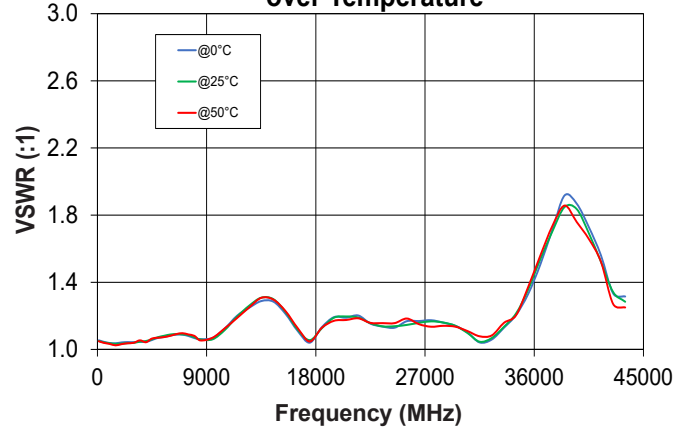

**VSWR J1 @ J1 Active over Temperature**

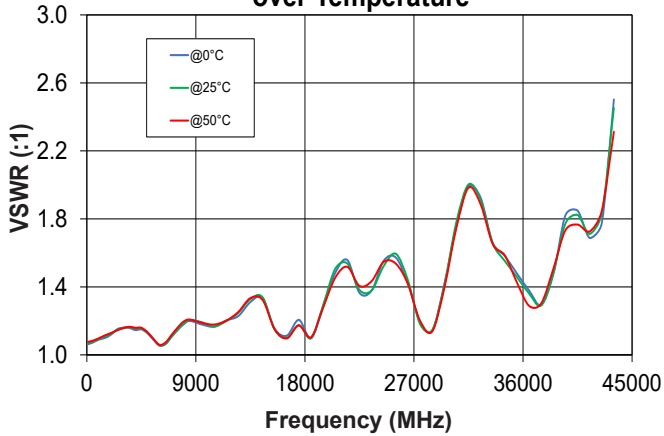

**VSWR J2 @ J2 Active over Temperature**

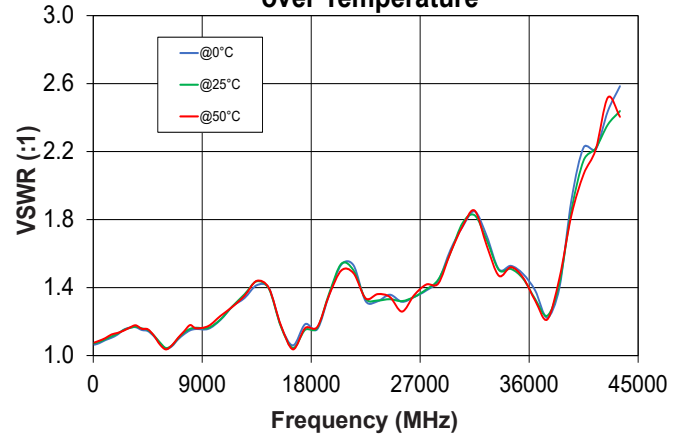

**VSWR COM @ J1 Active over Temperature**

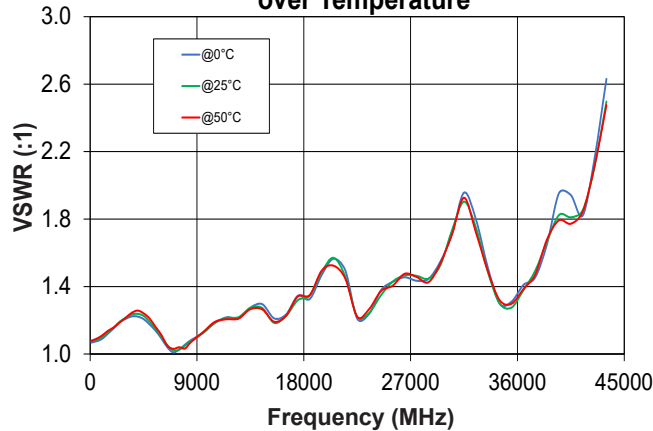

## Software & Documentation Download:

- Mini-Circuits' full software and support package including user guide, Windows GUI, DLL files, programming manual and examples can be downloaded free of charge from <https://www.minicircuits.com/softwaredownload/solidstate.html>
- Please contact [testsolutions@minicircuits.com](mailto:testsolutions@minicircuits.com) for support

## Minimum System Requirements

Parameter	Requirements	
Interface	USB HID	
System requirements	GUI:	Windows 32 & 64 bit systems from Windows 98 up to Windows 10
	USB API (ActiveX & .Net)	Windows 32 & 64 bit systems with ActiveX or .Net support from Windows 98 up to Windows 10
	USB direct programming support	Linux, Windows systems from Windows 98 up to Windows 10
Hardware	Pentium® II or higher, RAM 256 MB	

## Graphical User Interface (GUI) for Windows

### Key Features:

- Set each switch manually
- Set timed sequence of switching states
- Controlling up to 25 switch modules in 'daisy chain' configuration.
- USB control of switches
- Configure switch address and upgrade Firmware

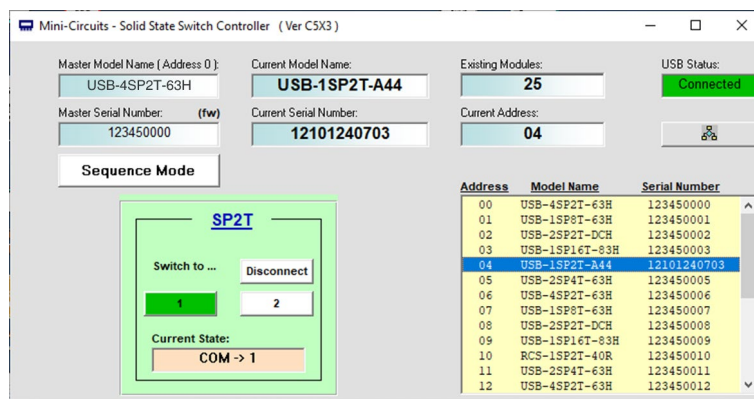

## Application Programming Interface (API)

### Windows Support:

- API DLL files exposing the full switch functionality See programming manual for details
  - ActiveX COM DLL file for creation of 32-bit programs
  - .Net library DLL file for creation of 32 / 64-bit programs
- Supported by most common programming environments (refer to application note [AN-49-001](#) for summary of tested environments)

### Linux Support:

- Full switch control in a Linux environment is achieved by way of USB interrupt commands. See programming manual at [https://www.minicircuits.com/softwaredownload/Prog\\_Manual-H\\_Series\\_Switches.pdf](https://www.minicircuits.com/softwaredownload/Prog_Manual-H_Series_Switches.pdf) for details



## Ordering Information

Model	Description
USB-1SP2T-A44	USB / Daisy Chain RF SPDT Switch

Included Accessories	Part No.	Description
	USB-CBL-AC-3+	3.3 ft (1.0 m) USB Cable: USB type A(Male) to USB type C(Male)

Optional Accessories	Description
USB-AC/DC-5+	AC/DC 5V <sub>DC</sub> Power Adapter with US, EU, IL, UK, AUS, and China power plugs <sup>10,11</sup>
USB-CBL-AC-3+ (spare)	3.3 ft (1.0 m) USB Cable: USB type A(Male) to USB type C(Male)
USB-CBL-CC-3+	3.3 ft (1.0 m) USB Cable: USB type C(Male) to USB type C(Male)
CBL-1.5FT-MMD+	1.5 ft (0.5 m) Digital Snap Fit(male-male) cable assembly(daisy chain)
CBL-5FT-MMD+	5 ft (1.5 m) Digital Snap Fit(male-male) cable assembly(daisy chain)

<sup>10</sup> The USB-AC/DC-5 may be used to provide the 5V<sub>DC</sub> power input via USB port if operating the switch as slave in Daisy Chain control. Not required if using USB control.

<sup>11</sup> Power plugs for other countries are also available, Plugs for other countries are also available, if you need a power plug for a country not listed please contact [testsolutions@minicircuits.com](mailto:testsolutions@minicircuits.com)

## Additional Notes

- A. Performance and quality attributes and conditions not expressly stated in this specification document are intended to be excluded and do not form a part of this specification document.
- B. Electrical specifications and performance data contained in this specification document are based on Mini-Circuit's applicable established test performance criteria and measurement instructions.
- C. The parts covered by this specification document are subject to Mini-Circuits standard limited warranty and terms and conditions (collectively, "Standard Terms"); Purchasers of this part are entitled to the rights and benefits contained therein. For a full statement of the Standard Terms and the exclusive rights and remedies thereunder, please visit Mini-Circuits' website at [www.minicircuits.com/MCLStore/terms.jsp](http://www.minicircuits.com/MCLStore/terms.jsp)

