

High Power Wideband Amplifier

ZVE-6W-83+

50Ω 2 to 8 GHz

The Big Deal

- Extremely wideband, 2 to 8 GHz
- Flat Gain, 33 ±2 dB typ.
- High IP3, +40 dBm typ.
- 6W Pout at saturation typ.



ZVE-6W-83+



ZVE-6W-83X+

Product Overview

Mini-Circuits' ZVE-6W-83+ is a Class-AB, four-stage, unconditionally stable amplifier providing flat gain over a wide frequency range from 2 to 8 GHz. This model is capable of delivering up to 6W output power at Psat with high IP3 supporting a wide range of systems where high performance over wideband is needed. It operates on a +15V supply and features built-in safety features including protection against reverse bias and immunity to accidental open or short loads. The amplifier comes in a rugged, compact case (2.61 x 2.43 x 0.74") with SMA connectors and an optional heat sink for efficient cooling.

Key Features

Feature	Advantages
Wideband, 2 to 8 GHz Able to work from 1.5 to 9 GHz	Enables a single amplifier to be used in a wide range of applications.
Excellent gain flatness, ±2.0 dB across full frequency range	Provides consistent performance across its operating frequency, minimizing the need for external equalizing networks in wideband applications.
High gain, 33 dB typ.	Reduces the number of gain stages, lowering component count and overall system cost.
Class AB Amplifier	Provides good linearity with low signal distortion.
Rugged design	Built-in protection against reverse bias and accidental open and short loads provides added reliability for demanding operating conditions.

High Power Wideband Amplifier

ZVE-6W-83+

50Ω 2 to 8 GHz

Features

- Wideband, 2 to 8 GHz
- High IP3, 40 dBm typ.
- Medium power output, 6W dBm
- High flat gain, 33±2 dB typ.

Applications

- Radar and military
- Test instrumentation
- Satellite repeaters
- Communication



Generic photo used for illustration purposes only

Model No.	ZVE-6W-83+	ZVE-6W-83X+ [▲]
Case Style	CP1978-1	
Connectors	SMA	

+RoHS Compliant

The +Suffix identifies RoHS Compliance. See our web site for RoHS Compliance methodologies and qualifications

Electrical Specifications at 25°C

Parameter	Condition (GHz)	ZVE-6W-83+ ZVE-6W-83X+ [▲]			Units
		Min.	Typ.	Max.	
Frequency Range		2	—	8	GHz
Gain	2 - 8	29	33	41	dB
Gain Flatness	2 - 8	—	±2.0	±3.5	dB
Output Power at 1dB compression	2 - 8	34	37	—	dBm
Output Power at Saturation	2 - 8	37	40	—	dBm
Noise Figure	2 - 8	—	10	12	dB
Output third order intercept point	2 - 8	—	40	—	dBm
Input VSWR	2 - 8	—	1.9	2.5	:1
Output VSWR	2 - 8	—	1.4	2.5	:1
DC Supply Voltage		14	15*	16	V
Supply Current [†]		—	0.8	5	A

[†] Power Supply should be capable of delivering 15V 5A at start-up.
* Recommended Operating Voltage.

[▲] Heat sink not included. Alternative heat sinking and heat removal must be provided by the user to limit maximum base-plate temperature to 85°C, in order to ensure proper performance. For reference, this requires thermal resistance of user's external heat sink to be 0.3°C/W max.

Maximum Ratings

Parameter	Ratings
Operating Temperature	ZVE-6W-83+ -40°C to 60°C ambient
	ZVE-6W-83X+ -40°C to 85°C base plate temp.
Storage Temperature	-55°C to 125°C
DC Voltage	18V
CW Input RF Power (no damage)	+20 dBm @ load
	0 dBm @ open / short

Permanent damage may occur if any of these limits are exceeded.

Outline Drawing for models with heatsink

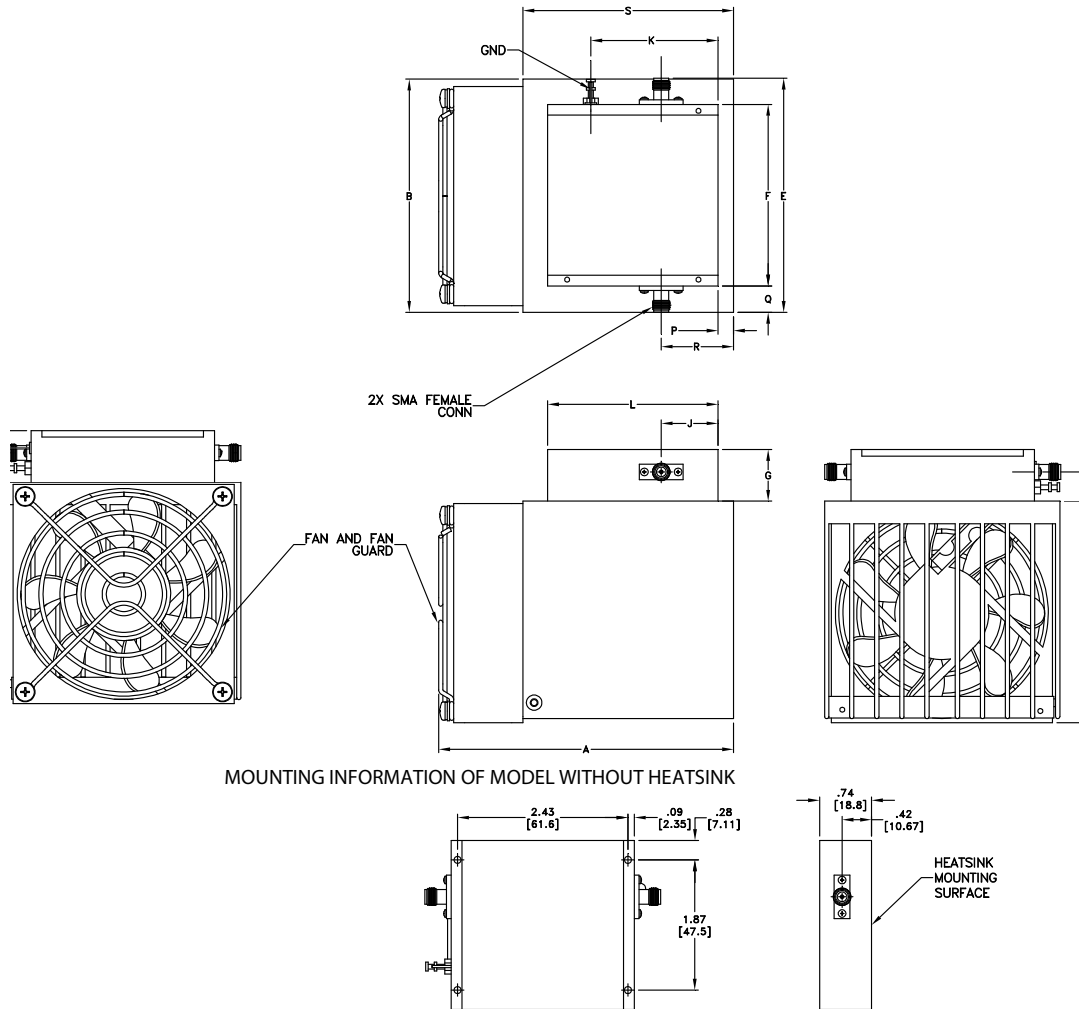

MOUNTING INFORMATION OF MODEL WITHOUT HEATSINK

Outline Dimensions (inch/mm)

A	B	C	D	E	F	G	J
4.20	3.35	3.92	3.60	3.36	2.61	.74	.81
106.68	85.09	99.57	91.44	85.34	66.29	18.80	20.57
K	L	N	P	Q	R	S	wt
1.81	2.43	.42	.22	.38	1.03	3.00	grams*
45.97	61.72	10.67	5.59	9.65	26.16	76.20	750.0

*290 grams without heatsink

FREQUENCY (MHz)	GAIN (dB)	DIRECTIVITY (dB)	VSWR (:1)		POUT at 1 dB COMPR. (dBm)	POUT at SATURATION (dBm)	NOISE FIGURE (dB)	OIP3 (dBm)
	15V	15V	IN	OUT	15V	15V	15V	15V
2000	34.64	54.82	1.96	1.63	38.85	41.38	9.90	43.18
2500	36.22	42.11	1.77	1.22	38.96	41.03	7.88	40.26
3000	34.21	39.25	1.91	1.24	38.38	40.27	7.23	40.30
3500	35.39	35.29	1.85	1.33	37.88	40.33	6.19	39.76
4000	36.48	36.29	1.46	1.39	37.92	40.22	5.48	39.00
4500	36.71	37.06	1.02	1.20	38.82	40.94	5.41	39.36
5000	36.17	44.52	1.33	1.01	39.99	41.56	5.41	40.75
5500	35.33	56.18	1.50	1.27	39.33	41.12	5.65	40.66
6000	34.33	53.75	1.38	1.33	39.06	40.56	5.81	40.57
6500	33.54	53.75	1.02	1.32	38.25	40.25	5.99	40.06
7000	33.14	50.83	1.19	1.32	37.76	40.08	6.14	39.55
7500	33.86	44.23	1.46	1.21	38.31	40.56	6.12	39.81
8000	34.21	46.86	1.64	1.59	38.31	40.55	5.97	41.08

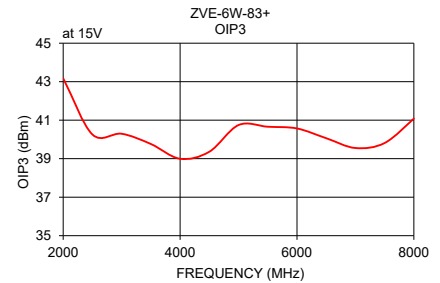
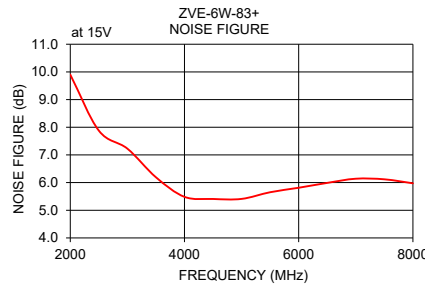
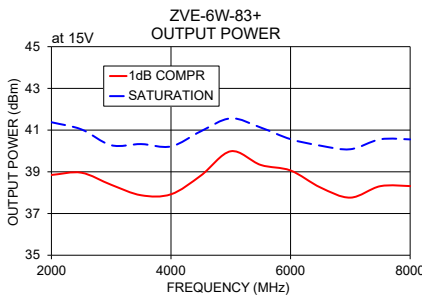
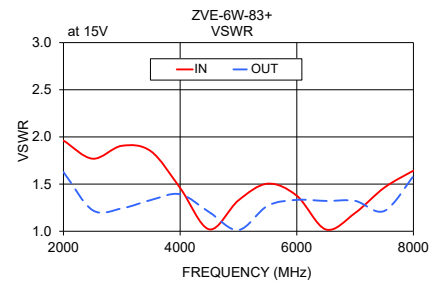
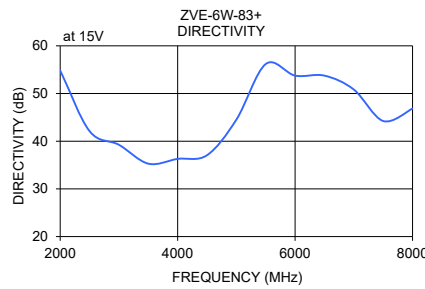
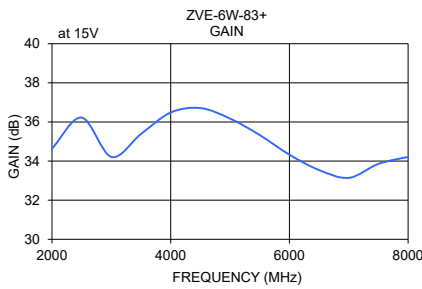

Additional Notes

- A. Performance and quality attributes and conditions not expressly stated in this specification document are intended to be excluded and do not form a part of this specification document.
- B. Electrical specifications and performance data contained in this specification document are based on Mini-Circuit's applicable established test performance criteria and measurement instructions.
- C. The parts covered by this specification document are subject to Mini-Circuits standard limited warranty and terms and conditions (collectively, "Standard Terms"); Purchasers of this part are entitled to the rights and benefits contained therein. For a full statement of the Standard Terms and the exclusive rights and remedies thereunder, please visit Mini-Circuits' website at www.minicircuits.com/MCLStore/terms.jsp