

# Surface Mount Voltage Controlled Oscillator

## JTOS-50P+

### 5V Tuning for PLL IC's 24 to 29 MHz

#### Features

- low phase noise
- 5V tuning voltage range
- linear tuning characteristics
- aqueous washable

#### Applications

- PLL circuitry
- measurement instrumentation
- frequency synthesizers

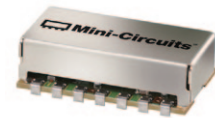

CASE STYLE: BK377  
PRICE: \$14.95 ea. QTY (5-49)

#### +RoHS Compliant

The +Suffix identifies RoHS Compliance. See our web site for RoHS Compliance methodologies and qualifications

#### Electrical Specifications

FREQUENCY (MHz)		POWER OUTPUT (dBm)	TUNING VOLTAGE (V)		PHASE NOISE (dBc/Hz) SSB at offset frequencies: Typ.				PULLING pk-pk @ 12 dB (MHz)	PUSHING (MHz/V)	TUNING SENSITIVITY (MHz/V)	HARMONICS (dBc)		3 dB MODULATION BANDWIDTH (MHz)	POWER SUPPLY	
Min.	Max.	Typ.	Min.	Max.	1 kHz	10 kHz	100 kHz	1 MHz	Typ.	Typ.	Typ.	Typ.	Max.	Typ.	Voltage (V)	Current (mA) Max.
24	29	+9.5	0.5	5.0	-88	-108	-127	-147	0.06	0.04	2-2.5	-14	-12	0.05	12	20

#### Pin Connections

RF OUT	13
VCC	2
V-TUNE	5
GROUND	1,3,4,6,7,8,9,10,11,12,14

#### Maximum Ratings

Operating Temperature	-55°C to 85°C
Storage Temperature	-55°C to 100°C
Absolute Max. Supply Voltage (Vcc)	+16V
Absolute Max. Tuning Voltage (Vtune)	+7V

all specifications: 50 ohm system  
Permanent damage may occur if any of these limits are exceeded.

#### Outline Drawing

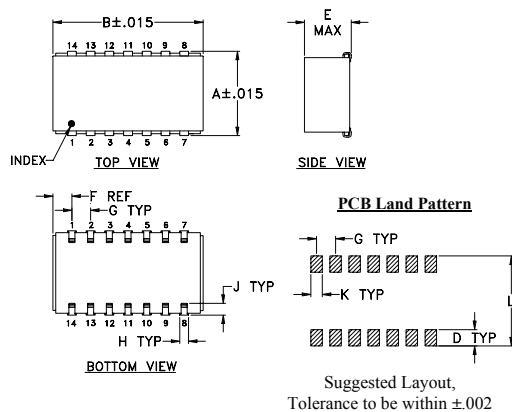

#### Demo Board MCL PIN: TB-04 Suggested PCB Layout (PL-005)

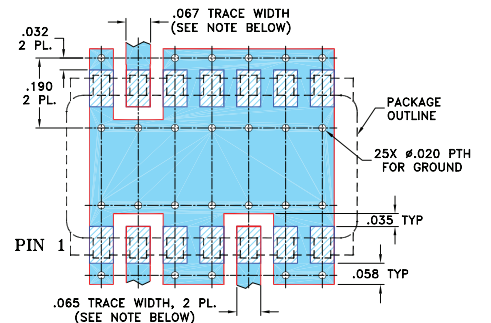

#### Outline Dimensions (inch/mm)

A	B	C	D	E	F	G	H	J	K	L	wt
.505	.800	--	.100	.250	.100	.100	.047	.065	.065	.525	grams
12.83	20.32	--	2.54	6.35	2.54	2.54	1.19	1.65	1.65	13.34	3.0

#### Notes

- A. Performance and quality attributes and conditions not expressly stated in this specification document are intended to be excluded and do not form a part of this specification document.  
B. Electrical specifications and performance data contained in this specification document are based on Mini-Circuit's applicable established test performance criteria and measurement instructions.  
C. The parts covered by this specification document are subject to Mini-Circuits standard limited warranty and terms and conditions (collectively, "Standard Terms"); Purchasers of this part are entitled to the rights and benefits contained therein. For a full statement of the Standard Terms and the exclusive rights and remedies thereunder, please visit Mini-Circuits' website at [www.minicircuits.com/MCLStore/terms.jsp](http://www.minicircuits.com/MCLStore/terms.jsp)



# Performance Data & Curves

# JTOS-50P+

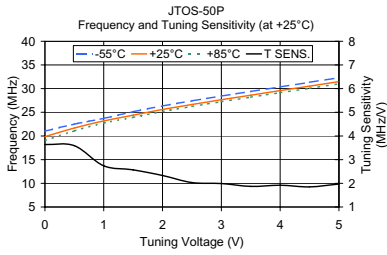

V TUNE	TUNING SENS. (MHz/V)	FREQUENCY (MHz)			POWER OUTPUT (dBm)		
		-55°C	+25°C	+85°C	-55°C	+25°C	+85°C
0.00	3.64	21.03	19.87	19.00	6.92	6.99	6.38
0.50	3.59	22.51	21.68	21.07	7.58	8.01	7.68
1.00	2.74	23.72	23.17	22.73	8.30	9.01	8.94
1.50	2.57	25.14	24.38	23.94	8.99	9.68	9.70
2.00	2.33	26.34	25.60	25.16	9.27	10.03	9.80
2.50	2.03	27.42	26.65	26.25	9.29	10.03	9.80
3.00	1.99	28.43	27.66	27.24	9.29	10.01	9.77
3.50	1.87	29.40	28.61	28.20	9.27	9.97	9.72
4.00	1.92	30.37	29.58	29.14	9.23	9.91	9.65
4.50	1.85	31.34	30.52	30.08	9.16	9.85	9.58
5.00	1.97	32.32	31.49	31.03	9.10	9.78	9.50

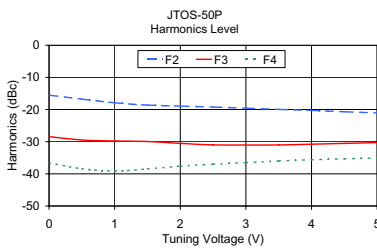
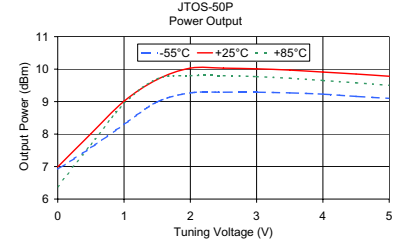

V TUNE	HARMONICS (dBc)			FREQ. PUSHING (MHz/V)
	F2	F3	F4	
0.00	-15.51	-28.42	-36.61	0.00
0.50	-16.74	-29.48	-38.42	0.00
1.00	-17.90	-29.78	-39.10	-0.06
1.50	-18.60	-29.95	-38.48	-0.13
2.00	-18.92	-30.54	-37.60	0.00
2.50	-19.22	-31.00	-36.99	-0.06
3.00	-19.57	-31.04	-36.50	-0.06
3.50	-19.95	-31.01	-35.98	0.06
4.00	-20.26	-30.78	-35.60	0.00
4.50	-20.69	-30.54	-35.34	0.00
5.00	-21.04	-30.28	-35.11	0.00

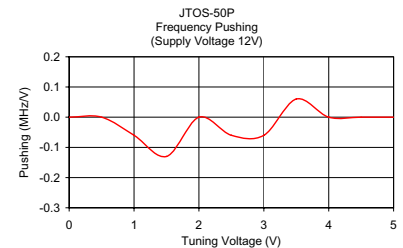

**Notes**

- A. Performance and quality attributes and conditions not expressly stated in this specification document are intended to be excluded and do not form a part of this specification document.
- B. Electrical specifications and performance data contained in this specification document are based on Mini-Circuits' applicable established test performance criteria and measurement instructions.
- C. The parts covered by this specification document are subject to Mini-Circuits standard limited warranty and terms and conditions (collectively, "Standard Terms"); Purchasers of this part are entitled to the rights and benefits contained therein. For a full statement of the Standard Terms and the exclusive rights and remedies thereunder, please visit Mini-Circuits' website at [www.minicircuits.com/MCLStore/terms.jsp](http://www.minicircuits.com/MCLStore/terms.jsp)

